



IFI GELATO COLLECTION



2 BELLEVUE
Panorama® tubs



6 BELLEVUE
Panorama® pans



8 PANORAMA®



10 ALLURE
Panorama® pans



12 POPAPP
Panorama® tubs



14 BIT
Panorama® tubs/pans



16 FAST PANORAMA®
Panorama® tubs



18 GELATO COW JOY
Panorama® tubs



22 GELATO COOLBOX TUBS



24 GELATO COOLBOX PANS



26 TONDA



30 CLOUD



34 SCREEN



38 LUNETTE



42 CUBIKA



44 SAM80



48 AKTIVA



50 JOLLY HYBRID



52 JET VBD



53 JET VAC



54 SNACK&FOOD
GELATO



55 FAST POZZETTI



56 POZZETTI



BELLEVUE Panorama® tubs

XXIII COMPASSO D'ORO ADI

BELLEVUE Panorama® tubs

For the first time in the history of the ADI (Associazione per il Disegno Industriale) **Compasso d'Oro**, the most authoritative institution in the design world has given its highest award to an artisan gelato display case.



BELLEVUE Panorama® tubs

Per la prima volta nella storia del **Compasso d'Oro** ADI (Associazione per il Disegno Industriale), l'istituzione più autorevole nel mondo del design ha premiato con il massimo riconoscimento una vetrina per il gelato artigianale.

BELLEVUE Panorama® tubs

Zum ersten Mal in der Geschichte des Preises **Compasso d'Oro** des Verbands für Industriedesign ADI (Associazione per il Disegno Industriale), einer der renommiertesten Institutionen der Welt des Designs, wurde die höchste Auszeichnung an eine Vitrine für Gelato aus Eigenproduktion verliehen.



BELLEVUE Panorama® tubs

Pour la première fois de son histoire, le prix **Compasso d'Oro** - la plus prestigieuse des récompenses remise par l'ADI (Associazione per il Disegno Industriale), l'institution la plus influente dans l'univers du design - a été décerné à une vitrine pour gelato artisanal.

BELLEVUE Panorama® tubs

Por primera vez en la historia del **Compasso d'Oro** ADI (Associazione per il Disegno Industriale), la institución más acreditada del mundo del diseño ha galardonado con el máximo reconocimiento a una vitrina para el gelato artesanal.

+Plus

1. It's a pozzetto, the best way of preserving gelato
2. Unlike normal pozzetti, **the gelato can be seen**
3. It is only 70 cm deep
4. Just 87 cm tall, it is easy to use and improves the view of the flavours
5. It is easy to clean.

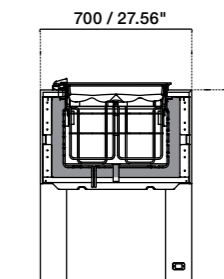

+Plus

1. È un pozzetto, il miglior modo di conservare il gelato
2. Diversamente dai normali pozzetti, **il gelato si vede**
3. È profondo solo 70 cm
4. Alto appena 87 cm, è ergonomico ed esalta la visione dei gusti
5. È facile da pulire.

+Plus

1. Il s'agit d'un pozzetto, le meilleur moyen de conserver le gelato
2. Contrairement aux pozzetti normaux, **le gelato est visible**
3. Il fait seulement 70 cm de profondeur
4. Mesurant à peine 87 cm de hauteur, il est ergonomique et exalte la visibilité des parfums
5. Il est facile à nettoyer.

+Plus

1. Es handelt sich um eine Pozzetti-Theke, d.h. die beste Form der Aufbewahrung für Gelato
2. Anders als beim herkömmlichen Pozzetto ist das **Gelato sichtbar**
3. Die Theke ist nur 70 cm tief
4. Die Theke ist nur 87 cm hoch, ergonomisch gestaltet und auf optimale Ausstellung der Eissorten ausgelegt
5. Einfache Reinigung.

+Plus

1. Es un pozzetto, la mejor manera de conservar el gelato
2. Al contrario de lo que sucede con los pozzetti normales, **el gelato se ve**
3. Tiene tan solo 70 cm de profundidad
4. De tan solo 87 cm de altura, es ergonómico y exalta la visión de los sabores
5. Es fácil de limpiar.



BELLEVUE

Panorama® tubs

Design Marc Sadler + IFI R&D Dept.



Units

Moduli_Modules_Modulen_Módulos:

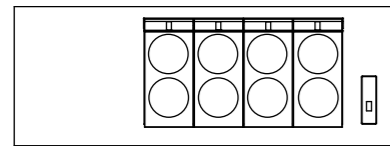

1900 / 74.80"

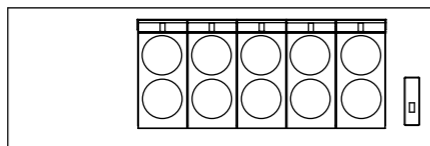

2150 / 84.65"

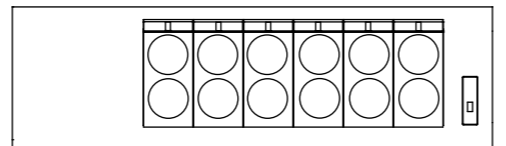

2400 / 94.49"

700 / 27.56"



BELLEVUE

Panorama® pans

Design Marc Sadler + IFI R&D Dept.



Units
Moduli_Modules_Modulen_Módulos:

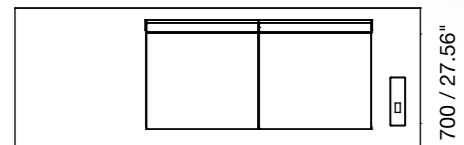

2031 / 79.96"

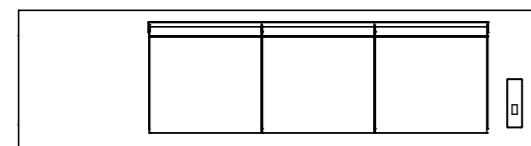

2596 / 102.20"



PANORAMA®

Design Marc Sadler + IFI R&D Dept.

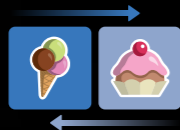

-14°C 7°F -5°C 23°F -18°C 0°F -13°C 9°F -12°C 10°F



250 / 9.84"

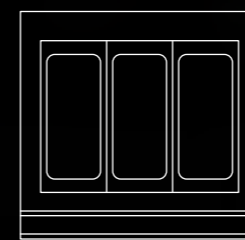

565 / 22.24"

550 / 21.65"

ALLURE

Panorama® pans



2487
97.91"

1922
75.67"

1357
53.43"



Units
Moduli_Modules_Modulen_Módulos:

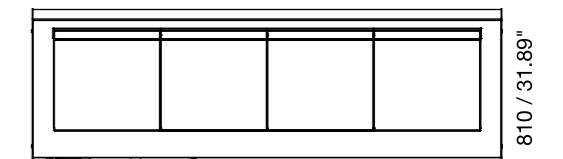

2487 / 97.91"

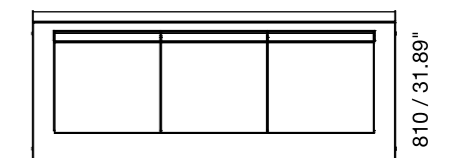

1922 / 75.67"

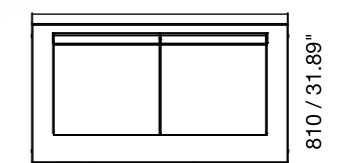

1357 / 53.43"

POPAPP

Panorama® tubs



5,2 m²

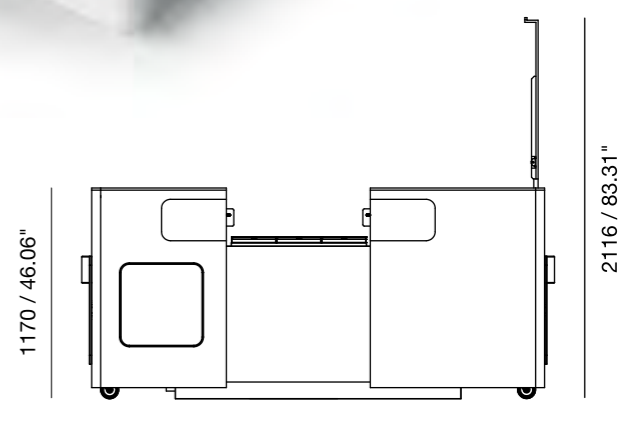
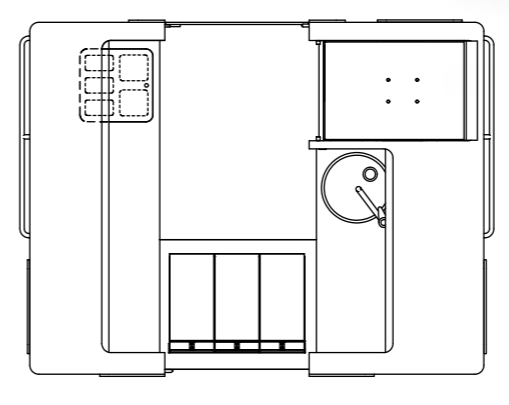

BIT

Panorama® tubs/pans

680
26.77"



365
14.37"



615
24.21"



865
34.06"



Units
Moduli_Modules_Modulen_Módulos:

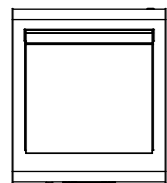

680 / 26.77"

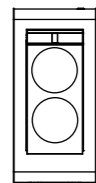

365 / 14.37"

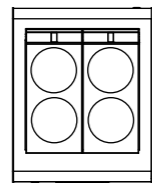

615 / 24.21"

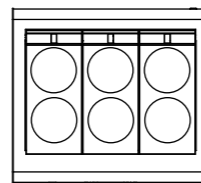

865 / 34.06"

770 / 30.31"

FAST PANORAMA®

Panorama® tubs



800
31.50"



1100
43.30"



1300
51.18"



1500
59.05"



Units
Moduli_Modules_Modulen_Módulos:

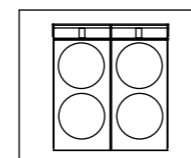

800 / 31.50"

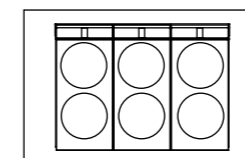

1100 / 43.30"

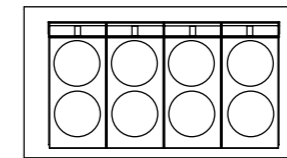

1300 / 51.18"

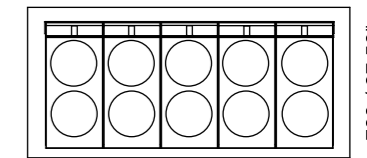

1500 / 59.05"

700 / 27.56"

GELATO COW JOY

Panorama® tubs

Design Riccardo Diotallevi + IFI R&D Dept.



Available configurations
 Configurazioni disponibili_Configuraciones disponibles_Erhältliche Konfigurationen_Configuraciones disponibles

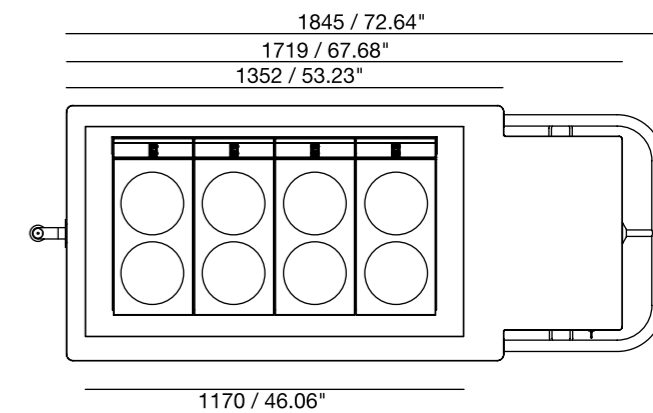
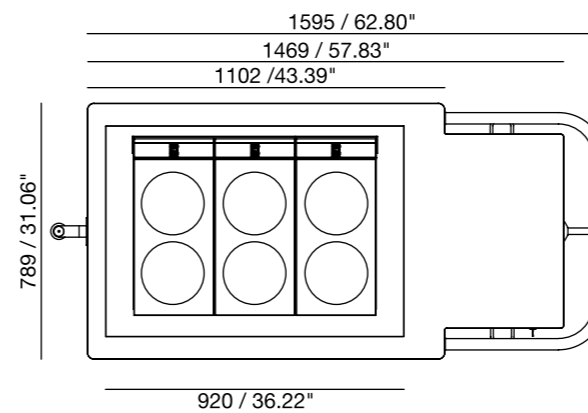
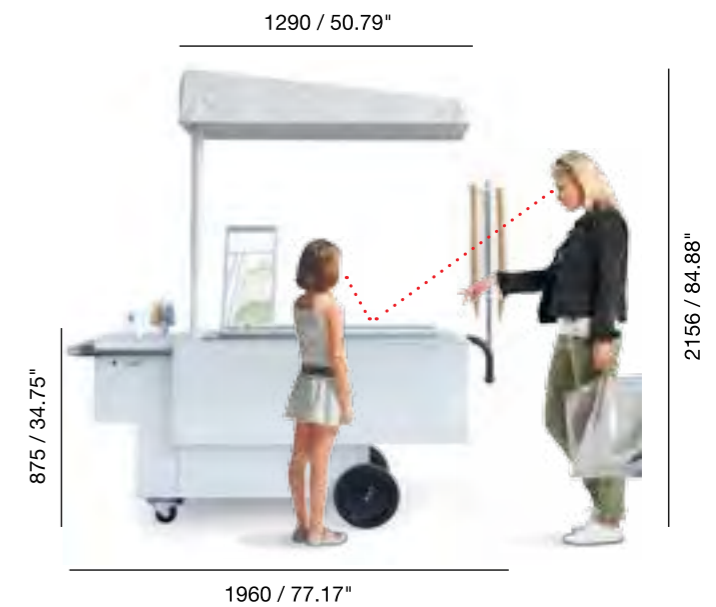

GELATO COW JOY

CE EAC

WHITE Version with electric canopy
Versione WHITE con tettino elettrico
Version WHITE (BLANC) avec auvent électrique
Version WHITE mit elektrischem Dach
Versión WHITE con techo eléctrico



WHITE Version without electric canopy
Versione WHITE senza tettino elettrico
Version WHITE (BLANC) sans auvent électrique
Version WHITE ohne elektrischen Dach
Versión WHITE sin techo eléctrico



COW Version with electric canopy
Versione COW con tettino elettrico
Version COW avec auvent électrique
Version COW mit elektrischem Dach
Versión COW con techo eléctrico



GELATO COOLBOX TUBS

Design Marc Sadler + IFI R&D Dept.

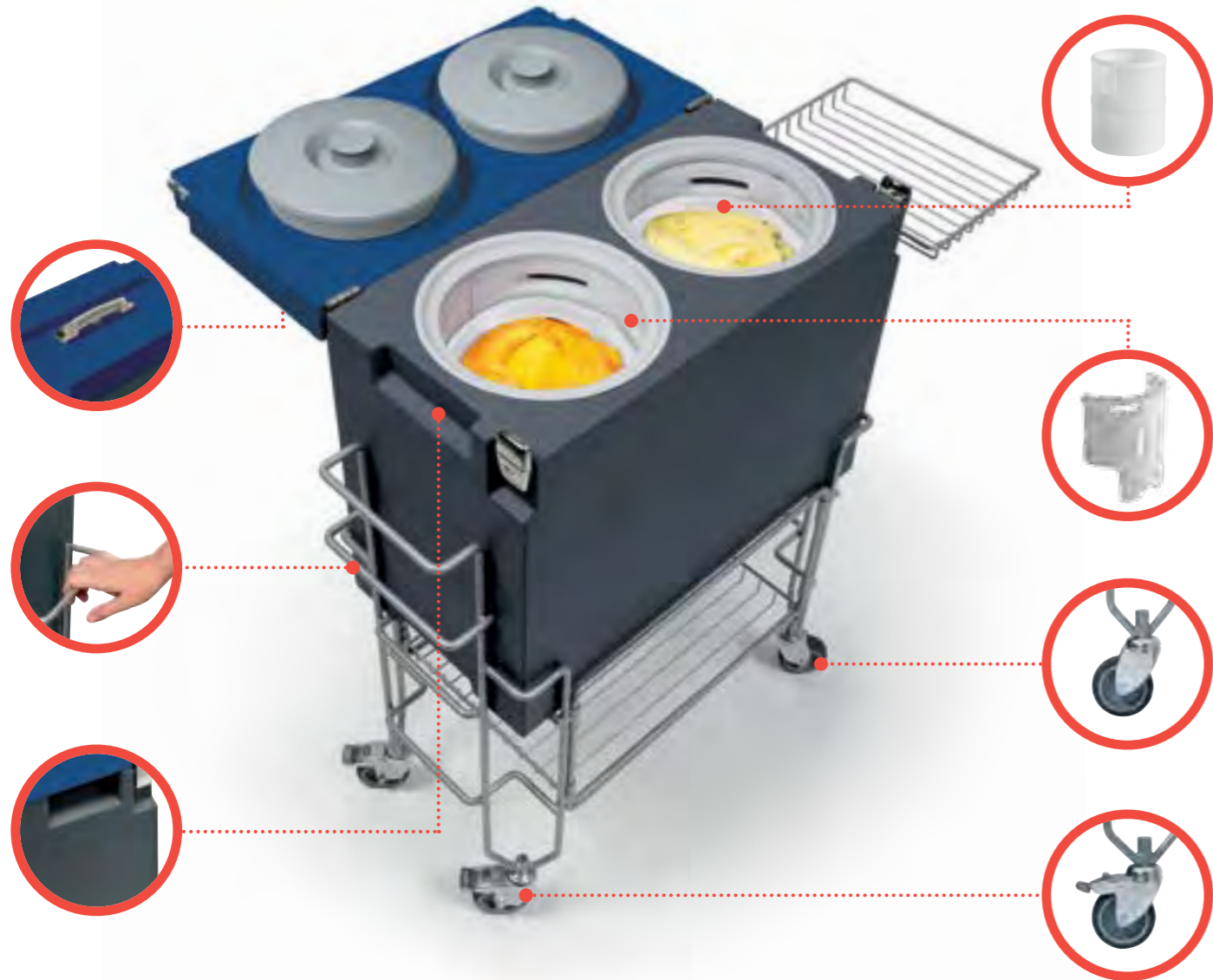

CART (Optional)
 Carrello (optional)
 Chariot (option)
 Wagen (Sonderausstattung)
 Carro (opcional)



FOR 1



FOR 2

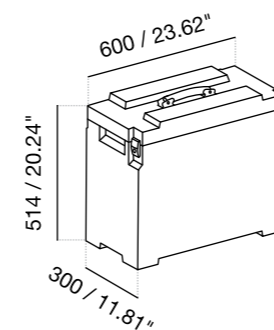

Powered by cooling packs!



GELATO COOLBOX PANS

Design Marc Sadler + IFI R&D Dept.

ERIC



Powered by cooling packs!

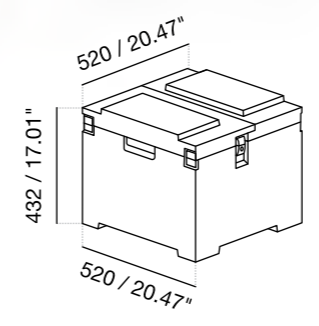
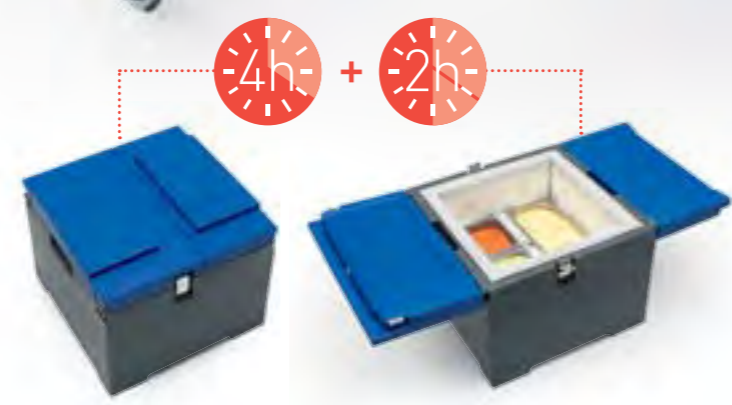

TONDA

Design Makio Hasuike & Co. + IFI R&D Dept.

Segnalazione
XXI 



TONDA



TONDA 12



TONDA 15



TONDA 18

PANS
Vaschette_Bacs
Gelatowannen_Cubetas
A: 5/7 Lt.
B: 4 Lt.
C: 5 Lt.

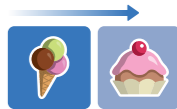
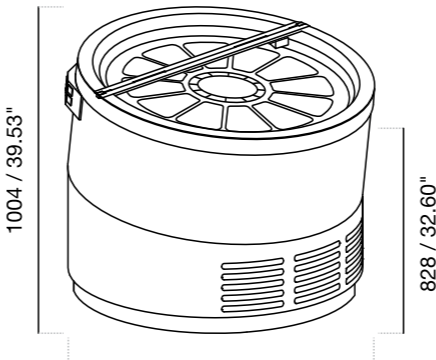

CLOUD

Design Makio Hasuike & Co. + IFI R&D Dept.

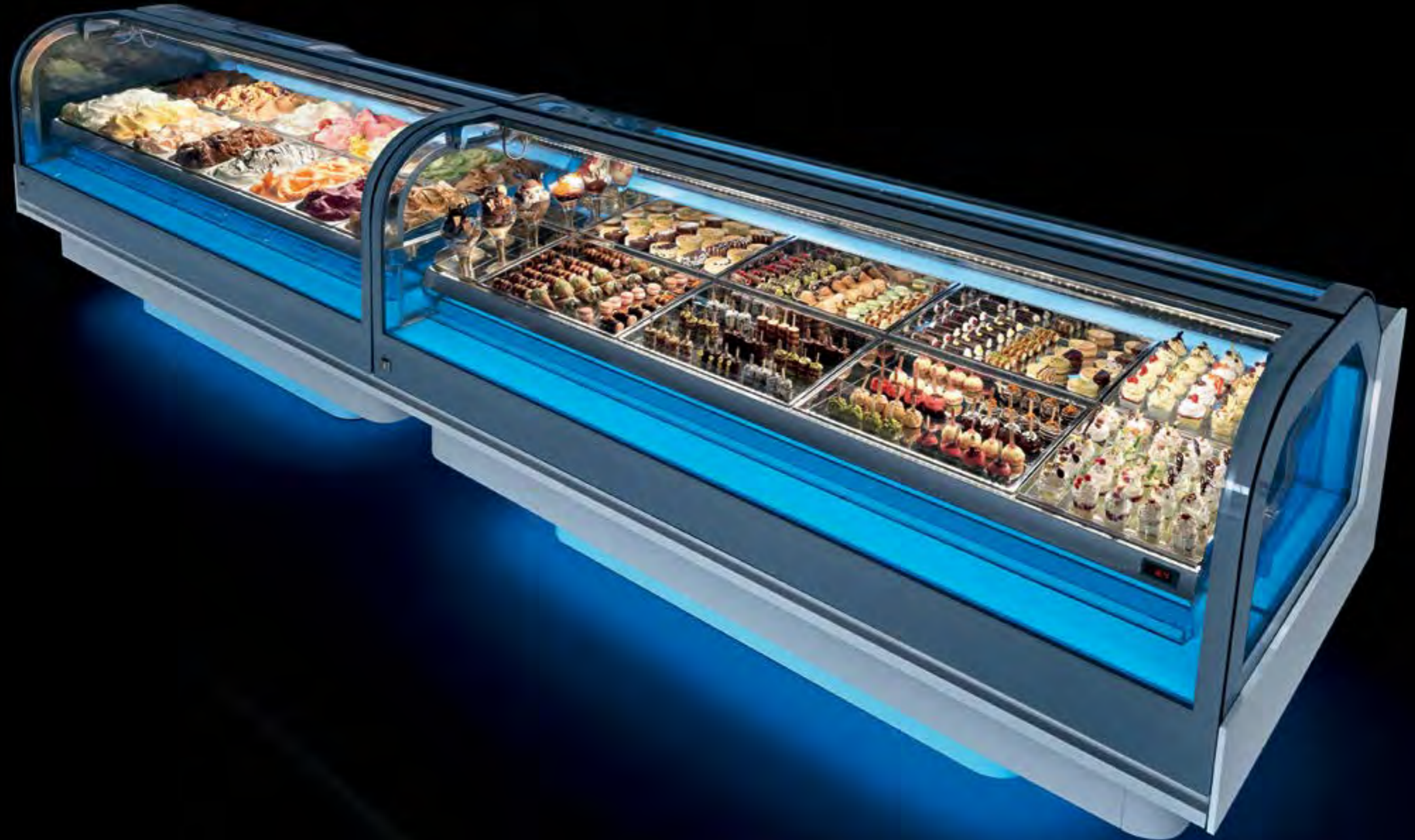



1224
48.19"



1724
67.87"



2224
87.56"



Cloud HCS



SCREEN

Design DELINEODESIGN + IFI R&D Dept.



SCREEN



1350
53.15"



1850
72.83"



2350
92.52"

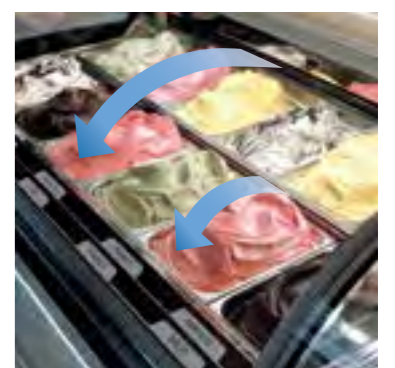
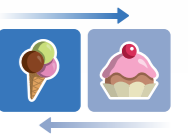

LUNETTE

Design DELINEODESIGN + IFI R&D Dept.



reddot design award
winner 2012



LUNETTE



1149
45.24"



1649
64.92"



2149
84.61"



CUBIKA

Design Valter Panaroni + IFI R&D Dept.

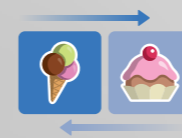

SAM80

Design IFI R&D Dept.



SAM80

2131
83.90"



1631
64.31"



1131
44.53"

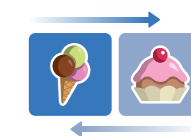

AKTIVA

Design IFI R&D Dept.

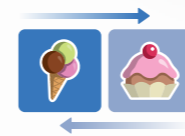

JOLLY HYBRID

Design Marc Sadler + IFI R&D Dept.



JET VBD

Design Valter Panaroni + IFI R&D Dept.



VBD

VBD:
Straight Low Glass_Vetri Bassi Diritti_Vitre Basse Droite
Niedrige Gerade Scheiben_Vidrios Bajos Rectos



JET VAC

Design Valter Panaroni + IFI R&D Dept.



VAC

VAC:
Curved High Glass_Vetri Alti Curvi_Vitre Haute Bombée
Hohe Gebogene Scheiben_Vidrios Altos Curvos



SNACK & FOOD GELATO

Design IFI R&D Dept.



CE ETL Intertek Intertek EAC

FAST POZZETTI

Design IFI R&D Dept.



CE ETL Intertek Intertek EAC



POZZETTI

Design IFI R&D Dept.



- 1. VENTILATED POZZETTI**
Pozzetti Ventilati_Pozzetti Ventilés
Pozzetti Umluftkühlung_Pozzetti Ventilados
- 2. GLYCOL POZZETTI**
Pozzetti a Glicole_Pozzetti Glycol
Pozzetti Glykolkühlung_Pozzetti Glicol
- 3.STATIC POZZETTI**
Pozzetti Statici_Pozzetti Statiques
Pozzetti Statisch_Pozzetti Estáticos
- 4. COMBINED POZZETTI**
Pozzetti Combinati_Pozzetti Combinés
Kombinierte Pozzetti_Pozzetti Combinados





ANTI-ROTATION TUBS

Carapine anti-rotazione_Bacs encastrables anti-rotation
Drehschutzbehälter_Cubetas anti-rotación



TUBS
Carapine / Bacs / Gelatobehälter / Cubetas

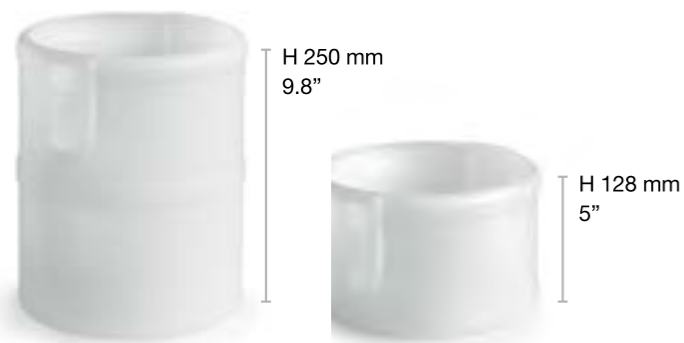

Polyethylene_Polietilene_Polyéthylène_Polyethylen_Polietileno



Steel_Acciao_Acier_Stahl_Acero



HCS CLOSURE SYSTEM

Sistema di Chiusura HCS_Système De Fermeture HCS
Verschlussystem „HCS“_Sistema De Cierre HCS

- 1 Thanks to the reduced number of defrosts (the HCS system activates defrosting based on how long the display case is actually open rather than at preset intervals), the gelato is better in terms of organoleptic characteristics and appearance.
- 2 HCS system reduces electricity consumption, with benefits for the environment, costs, and the condensing unit lifetime.
- 3 Beyond displaying gelato, the display case can work as a chiller cabinet.

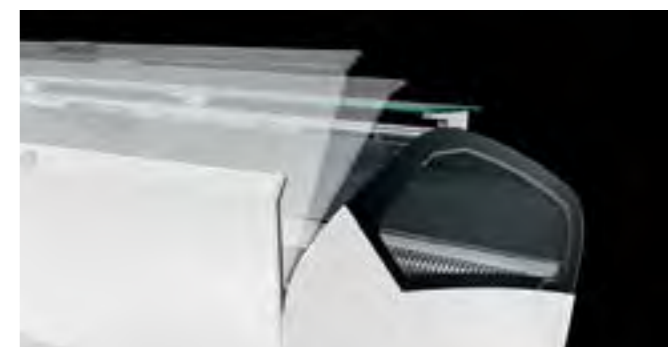

- | | | | |
|---|---|--|---|
| <p>1. Grazie al numero di sbrinamenti ridotto (il sistema HCS attiva gli sbrinamenti in base al tempo di effettiva apertura della vetrina invece che a intervalli di tempo preimpostati), il gelato è migliore nelle caratteristiche organoleptiche e nell'aspetto.</p> <p>2. Il sistema HCS riduce il consumo di energia elettrica, con benefici per l'ambiente, i costi di gestione e la durata del compressore.</p> <p>3. Oltre a esporre il gelato, la vetrina chiusa può fungere da armadio refrigerato.</p> | <p>1. Grâce à la réduction du nombre de dégivrages (le système HCS active les dégivrages sur la base du temps effectif d'ouverture de la vitrine et non à des intervalles de temps prééglés), le gelato a un meilleur aspect et conserve mieux ses caractéristiques organoleptiques.</p> <p>2. Le système HCS réduit la consommation d'énergie électrique, dont environnement, les coûts de gestion et la durée de vie du compresseur tirent bénéfice.</p> <p>3. Outre sa fonction de présentoir à gelato, la vitrine fait office d'armoire réfrigérante.</p> | <p>1. Durch die geringere Anzahl von Abtauvorgängen (das HCS System aktiviert das Abtauen je nach der tatsächlichen Öffnungszeit der Vitrine und nicht nach voreingestellten Intervallen) weist das Gelato im Hinblick auf seine organoleptischen Eigenschaften und sein Aussehen eine bessere Qualität auf.</p> <p>2. Das HCS-System reduziert den Stromverbrauch, was sich positiv auf die Umwelt, die Betriebskosten und die Lebensdauer des Kompressors auswirkt.</p> <p>3. Neben der Funktion der Präsentation des Gelatos kann die geschlossene Vitrine auch als Kühlschrank verwendet werden.</p> | <p>1. Gracias al reducido número de desescarches (el sistema HCS activa los desescarches en función del tiempo efectivo que la vitrina permanece abierta y no a intervalos de tiempo predeterminados), el gelato es mejor en cuanto a características organolépticas y aspecto.</p> <p>2. El sistema HCS reduce el consumo de energía eléctrica, con beneficios para el medio ambiente, los costes de gestión y la durabilidad del compresor.</p> <p>3. Además de exponer el gelato, la vitrina cerrada puede funcionar como armario refrigerado.</p> |
|---|---|--|---|





ACOUSTIC COMFORT SYSTEM

FROM 59 TO 56 DECIBELS

-3 decibels make the difference between the sound of waves breaking against the rocks and the placid, gentle movement of water on a tropical beach.

-3 decibels make the difference between working for a whole day, or even the whole year, in one environment rather than the other.

Acoustic Comfort System means operators' wellbeing and health and attention to customers, who are guests in a more comfortable and relaxing environment, to be enjoyed with all five senses.

Acoustic Comfort System is available for CUBIKA GELATO and 4 SEASONS - linear modules 1100, 1600, 2100 for all heights. AKTIVA GELATO and 4 SEASONS - linear modules 1100, 1600, 2100.



Cubika



Aktiva

56 DECIBEL



ACOUSTIC COMFORT SYSTEM DA 59 A 56 DECIBEL

-3 decibel sono la differenza tra il rumore delle onde che si infrangono contro gli scogli e il placido adagio dell'acqua sulla riva di una spiaggia tropicale.

-3 decibel sono la differenza tra lavorare una giornata intera, o tutto l'anno, in un ambiente invece che nell'altro.

Acoustic Comfort System significa benessere e salute degli operatori e attenzione verso i clienti, ospiti di un ambiente più confortevole e rilassante, da godere con tutti e 5 i sensi.

Acoustic Comfort System è disponibile su CUBIKA GELATO e 4 STAGIONI nei moduli lineari 1100, 1600, 2100 per tutte le altezze. AKTIVA GELATO e 4 STAGIONI nei moduli lineari 1100, 1600, 2100.

ACOUSTIC COMFORT SYSTEM (Système de confort acoustique) DE 59 A 56 DECIBELS

-3 décibels est la différence entre le bruit des vagues qui se brisent contre les rochers et l'adagio placide du rivage d'une plage tropicale.

-3 décibels est la différence entre le travail d'une journée complète, ou tout au long de l'année, dans un environnement plutôt que dans l'autre.

Acoustic Comfort System signifie le bien-être et la santé des opérateurs et de leur attention envers les clients, qui sont leurs hôtes dans un environnement plus confortable et relaxant, que l'on peut apprécier de ses cinq sens.

Acoustic Comfort System est disponible sur CUBIKA GELATO et 4 SAISONS sur les modules linéaires 1100, 1600 et 2100 et pour toutes les hauteurs. AKTIVA GELATO et 4 SAISONS sur les modules linéaires 1100, 1600 et 2100.

ACOUSTIC COMFORT SYSTEM VON 59 BIS 56 DEZIBEL

-3 Dezibel sind der Unterschied zwischen dem Getöse der Wellen, die sich an einer Klippe brechen, und ihrem sanft friedlichen Geplätscher, wenn sie einen Tropenstrand streicheln.

-3 Dezibel machen den Unterschied einer Arbeitsplatzumgebung aus, in der den ganzen Tag oder das ganze Jahr über gearbeitet wird.

Acoustic Comfort System bedeutet Wohlbefinden und Gesundheit für Ihre Mitarbeiter und zugleich Aufmerksamkeit für den Kunden, der eine angenehmere, entspannende Umgebung betritt, die er mit allen 5 Sinnen genießen kann.

Acoustic Comfort System ist für CUBIKA GELATO und 4 JAHRESZEITEN in den linearen Modulen 1100, 1600, 2100 für alle Höhen verfügbar. AKTIVA GELATO und 4 JAHRESZEITEN in den linearen Modulen 1100, 1600, 2100.

ACOUSTIC COMFORT SYSTEM DE 59 A 56 DECIBELIOS

-3 decibelios es la diferencia entre el ruido de las olas que rompen contra los escollos y la placida llegada del agua a la orilla de una playa tropical.

-3 decibelios es la diferencia entre trabajar un día entero, o todo el año, en un ambiente en vez que en el otro.

Acoustic Comfort System significa bienestar y salud de los operadores y atención hacia los clientes, que visitarán un ambiente más confortable y relajante para disfrutar con los 5 sentidos.

Acoustic Comfort System está disponible en CUBIKA GELATO y 4 ESTACIONES en los módulos lineales 1100, 1600, 2100 para todas las alturas. AKTIVA GELATO y 4 ESTACIONES en los módulos lineales 1100, 1600, 2100.

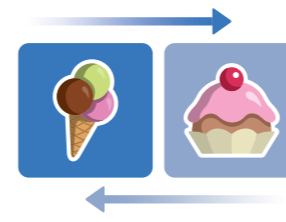

4 SEASONS From Gelato to Pastry



4 Seasons models of the IFI gelato display cases are available, allowing you to change from gelato mode (-12°/-18°C) to pastry mode (+4°/+8°C with average relative humidity of 60% to 70%) by simply pushing a button. With one click, you can transform your gelateria into a pastry parlour, allowing you to satisfy your customers' needs at any time of year.

To switch from Gelato to Pastry, simply:

- 1) Replace the pans with display trays (optional)
- 2) Click the green button once to switch it from on to off; that way the display case will automatically change to the pastry setting (+4°C / +39.2°F).



4 STAGIONI Da vetrina Gelato a Pasticceria

Le vetrine gelato IFI sono disponibili anche nella versione 4 STAGIONI in grado di funzionare sia come gelateria (-12°/-18°C) sia come pasticceria (+4°/+8°C con 60/70% di U.R. media), attivando semplicemente il pulsante di commutazione. È possibile trasformare il locale da gelateria a pasticceria in un click, a seconda del periodo dell'anno e delle esigenze della clientela.

- Per passare da Gelato a Pasticceria è sufficiente:
- 1) sostituire le vaschette con il vassoio espositivo (optional)
 - 2) Cliccare una sola volta il pulsante verde, che da acceso diventerà spento: in questo modo la vetrina passerà automaticamente alla funzione pasticceria (+4°C).

4 SAISONS De la vitrine Gelato à la vitrine Pâtisserie

Les vitrines gelato IFI sont disponibles également dans la version 4 SAISONS, laquelle nécessite d'actionner un simple bouton de commutation pour choisir soit la fonction glacière (-12°/-18°C) soit la fonction pâtisserie (+4°/+8°C avec 60/70% d'humidité relative moyenne). Il est possible de transformer l'établissement de glacière en pâtisserie en un seul clic, selon la période de l'année et les exigences de la clientèle.

- Pour passer de la fonction Gelato à la fonction Pâtisserie, il suffit de:
- 1) remplacer les bacs par le plateau d'exposition (en option)
 - 2) Appuyer une seule fois sur le bouton vert ; allumé, il s'éteint: de la sorte, la vitrine passe automatiquement à la fonction pâtisserie (+4°C).

4 JAHRESZEITEN Von der Gelato- zur Konditoreivitrine

Die IFI Gelatovitrinen sind auch in der Version 4 JAHRESZEITEN erhältlich, die sowohl für Gelato (-12°/-18 °C) als auch für Konditoreiwaren (+4°/+8 °C mit durchschnittl. 60/70 % rF) geeignet sind. Der Wechsel erfolgt einfach über eine Umschalttaste. Das Lokal kann je nach Jahreszeit und Vorlieben der Kunden mit einem Klick von einer Eisdiele in eine Konditorei verwandelt werden.

- Um vom Gelato- zum Konditoreibetrieb zu wechseln, einfach:
- 1) die Wannen durch das Ausstellungsblech (Sonderausstattung) ersetzen
 - 2) Nur einmal auf die grüne Taste klicken, die von ein auf aus wechselt: auf diese Weise schaltet die Vitrine automatisch auf die Funktion Konditorei (+4 °C).

4 ESTACIONES De vitrina de gelato a vitrina pastelería

Las vitrinas de gelato IFI también están disponibles en la versión 4 ESTACIONES, es decir, con función tanto de heladería (-12°/-18°C) como de pastelería (+4°/+8°C con 60/70% de H.R. media), simplemente activando el pulsador de conmutación. Se puede transformar el local de heladería a pastelería con un solo clic, en función del periodo del año y de las demandas de la clientela.

- Para pasar de gelato a pastelería es suficiente:
- 1) sustituir las cubetas con la bandeja expositiva (opcional)
 - 2) Haga clic una sola vez en el botón verde, que pasará de activado a desactivado: de este modo, la vitrina pasará automáticamente a la función de pastelería (+4 °C).

Accessories/Optionals

Accessori/Optional_Accessoires/Options
Zubehör/Optionals_Accesorios/Opcionales

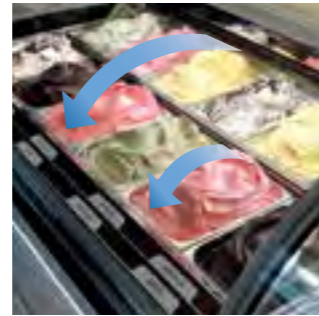

TONDA: Sticks and single portions
Stecchi e monoporzioni_Bâtons et monoportions
Einzelportion und Gelatostiele_Polos y monoporciones

Available with double air flow
Disponibile con doppia mandata dell'aria
Disponible à double flux d'air froid
Verfügbar mit doppelter Luftversorgung
Disponible con doble envío de aire

Cake pan accessory
Vasca portatorte
Accessoire bac d'exposition gâteaux
Tortenausstellungsfläche
Sobre para tartas

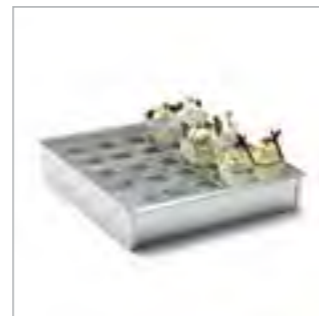

Gelato on a stick tray
Porta gelato su stecco_Support pour gelato sur bâton
Gelato-Ständer_Porta-gelato de palito

Single portions
Monoporzioni_Monoportions_Einzelportionen_Monoporciones

Topping Unit

Modulo Topping_Module Topping_Einbaumodul Topping_Módulo Topping



4 Gastronorm Pans
Vaschette_Bacs_Wannen_Cubetas



6 Gastronorm Pans
Vaschette_Bacs_Wannen_Cubetas

THE UNIT CAN EITHER HEAT - WARM FUNCTION, +40°C (+104°F) OR CHILL - COLD FUNCTION, +4°/+8°C (+39.2°F/+46.4°F).
Il modulo può alternativamente riscaldare (funzione WARM, +40°C) o refrigerare (funzione COLD, +4°/+8°C). _Le module peut alternativement chauffer (fonction WARM, +40°C) ou réfrigérer (fonction COLD, +4°/+8°C). _Das Modul kann entweder wärmen (Funktion WARM, +40°C) oder kühlen (Funktion COLD, +4°/+8°C). _El módulo puede calentar (función WARM, +40°C) o refrigerar (función COLD, +4°/+8°C).

Drawer unit for gelato pans

Cassettiera per vaschette gelato_Module à tiroirs pour bacs à gelato
Schubladenelement für Gelato-Wannen_Mueble con cajones para cubetas gelato



Pans_Vaschette_Bacs
Wannen_Cubetas:
260x160; 360x165; 360x250

Scoop washers

Lavaporzionatori_Lave-portionneuses_Eisportioniererspüler_Lavaporcionadores



Watersave scoop washer
Lavaporzionatore watersave
Lave-portionneuse watersave
Watersave Eisportioniererspüler
Lavaporcionador watersave



Streamlined scoop washer with tap
Lavaporzionatore carenato con rubinetto
Lave-portionneuse caréné avec robinet
Verkleideter Eisportioniererspüler mit Wasserhahn
Lavaporcionador carenado con grifo



Continuous-flow streamlined scoop washer
Lavaporzionatore carenato a flusso continuo
Lave-portionneuse caréné à débit continu
Verkleideter Eisportioniererspüler mit Dauerfluss
Lavaporcionador carenado de flujo continuo

260x160 = 10.24"x6.30"; 360x165 = 14.17"x6.50"; 360x250 = 14.17"x9.84"

Modules and Pans

Moduli e Vaschette_Modules et Bacs
Modulen und Gelatowannen_Módulos y Cubetas

Side panels included_Misure con fianchi_Mesures avec joues_Maße mit Endseitenteilen_Medidas con lados

PANS 360X165 (14.17"X6.50") / TRAPEZOIDAL

Vaschette 360x165 / Trapezoidal_i_Bacs 360x165/ Trapezoidal_
Gelatowannen 360x165 / Trapezoidal_Cubetas 360x165 / Trapezoidales

TONDA

Ø 1405 - 55.31"

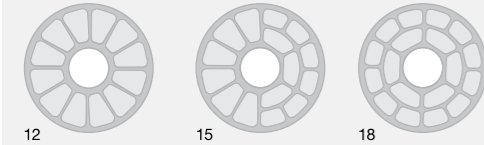

12 15 18

CLOUD



L 1224 - 48.19" L 1724 - 67.87" L 2224 - 87.56"
1018 - 40.08" 6+6 9+9 12+12

SCREEN

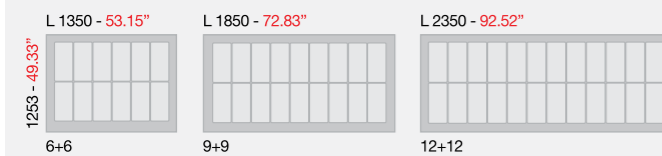

L 1350 - 53.15" L 1850 - 72.83" L 2350 - 92.52"
1253 - 49.33" 6+6 9+9 12+12

LUNETTE

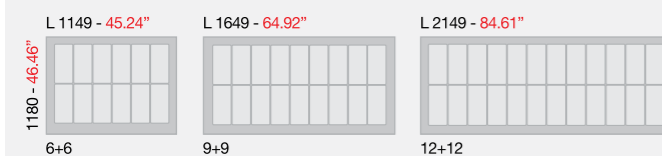

L 1149 - 45.24" L 1649 - 64.92" L 2149 - 84.61"
1180 - 46.46" 6+6 9+9 12+12

SAM80

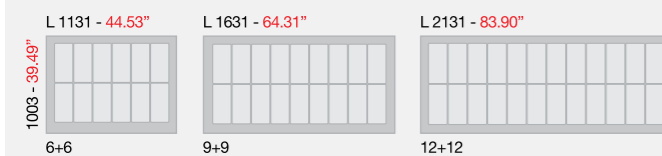

L 1131 - 44.53" L 1631 - 64.31" L 2131 - 83.90"
1003 - 39.49" 6+6 9+9 12+12

JOLLY HYBRID

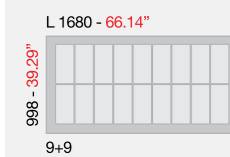

L 1680 - 66.14"
998 - 39.29" 9+9

PANS 360X250 (14.17"X9.84")

Vaschette 360x250_Bacs 360x250
Gelatowannen 360x250_Cubetas 360x250

CLOUD

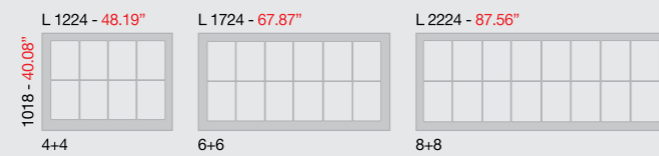

L 1224 - 48.19" L 1724 - 67.87" L 2224 - 87.56"
1018 - 40.08" 4+4 6+6 8+8

SCREEN

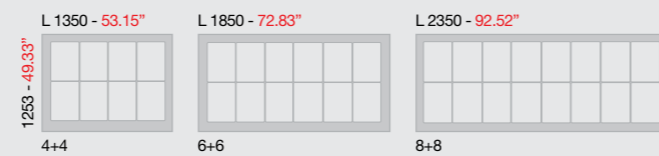

L 1350 - 53.15" L 1850 - 72.83" L 2350 - 92.52"
1253 - 49.33" 4+4 6+6 8+8

LUNETTE

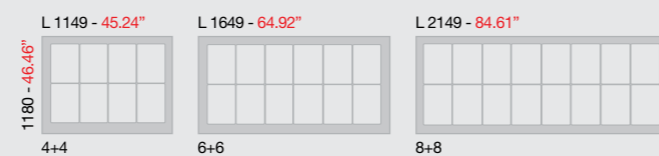

L 1149 - 45.24" L 1649 - 64.92" L 2149 - 84.61"
1180 - 46.46" 4+4 6+6 8+8

SAM80



L 1131 - 44.53" L 1631 - 64.31" L 2131 - 83.90"
1003 - 39.49" 4+4 6+6 8+8

JOLLY HYBRID

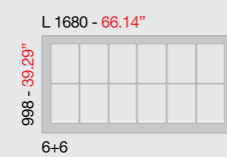

L 1680 - 66.14"
998 - 39.29" 6+6



PANS 360X165 (14.17"X6.50") / TRAPEZOIDAL

Vaschette 360x165 / Trapezoidal_i_Bacs 360x165/ Trapezoidal_
Gelatowannen 360x165 / Trapezoidal_Cubetas 360x165 / Trapezoidales

CUBIKA

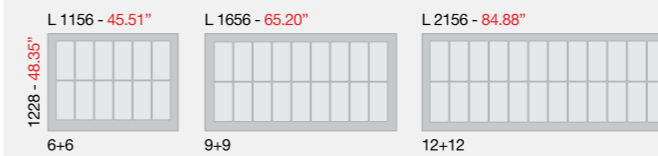

L 1156 - 45.51" L 1656 - 65.20" L 2156 - 84.88"
1228 - 48.35" 6+6 9+9 12+12

AKTIVA

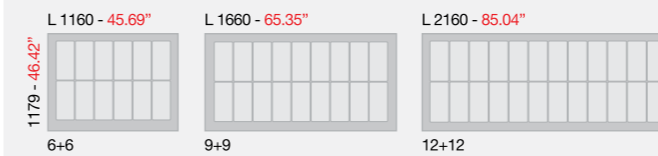

L 1160 - 45.69" L 1660 - 65.35" L 2160 - 85.04"
1179 - 46.42" 6+6 9+9 12+12

CUBIKA / AKTIVA

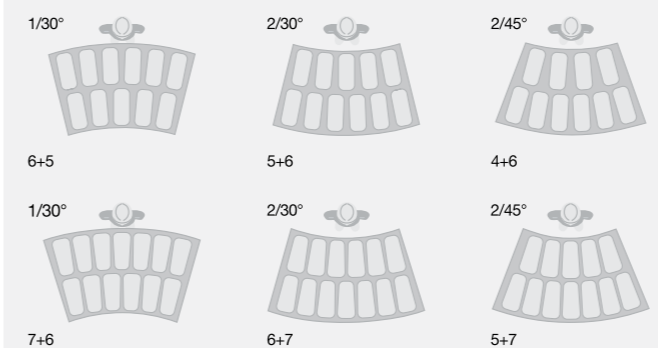

1/30° 2/30° 2/45°
6+5 5+6 4+6
1/30° 2/30° 2/45°
7+6 6+7 5+7

JET

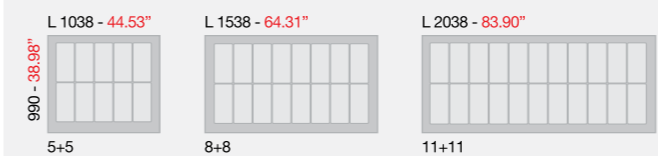

L 1038 - 44.53" L 1538 - 64.31" L 2038 - 83.90"
990 - 38.98" 5+5 8+8 11+11

SNACK&FOOD



L 1006 - 39.61" L 1506 - 59.29" L 2006 - 78.98"
732 - 28.82" 5 8 11

PANS 360X250 (14.17"X9.84")

Vaschette 360x250_Bacs 360x250
Gelatowannen 360x250_Cubetas 360x250

CUBIKA

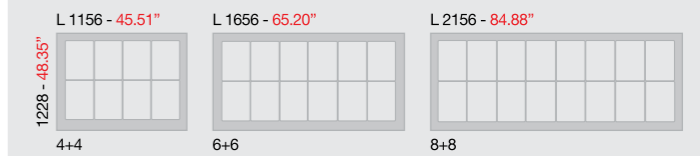

L 1156 - 45.51" L 1656 - 65.20" L 2156 - 84.88"
1228 - 48.35" 4+4 6+6 8+8

AKTIVA

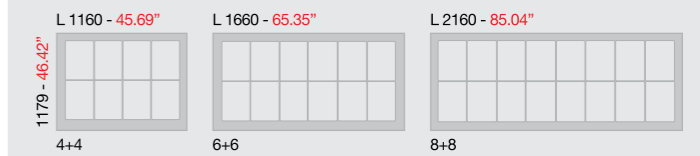

L 1160 - 45.69" L 1660 - 65.35" L 2160 - 85.04"
1179 - 46.42" 4+4 6+6 8+8

CUBIKA / AKTIVA

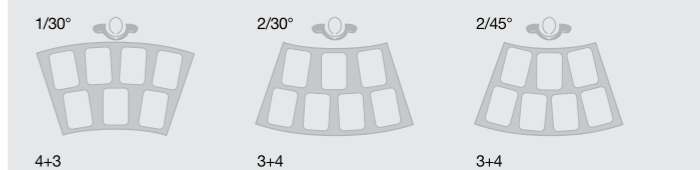

1/30° 2/30° 2/45°
4+3 3+4 3+4

JET

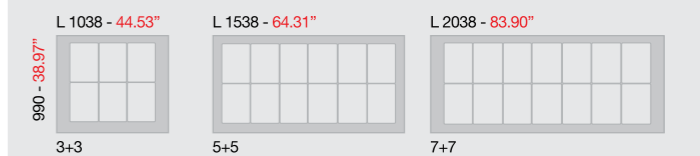

L 1038 - 44.53" L 1538 - 64.31" L 2038 - 83.90"
990 - 38.97" 3+3 5+5 7+7

IFI RESERVES THE RIGHT TO MAKE MODIFICATIONS TO THE PRODUCTS SHOWN IN THIS CATALOGUE AT ANY TIME WITHOUT PRIOR NOTICE. THE FINISHINGS SHOWN IN THIS CATALOGUE ARE APPROXIMATE, AS A PRINTED REPRODUCTION CAUSES INEVITABLE COLOUR DIFFERENCES.

IFI SI RISERVA IL DIRITTO DI APPORTARE MODIFICHE AI PRODOTTI ILLUSTRATI IN QUESTO CATALOGO, IN QUALUNQUE MOMENTO SENZA L'OBBLIGO DI PREAVVISO. LE FINITURE RIPRODOTTE IN QUESTO CATALOGO SONO INDICATIVE PER LE INEVITABILI DIFFERENZE DOVUTE ALLA RIPRODUZIONE TIPOGRAFICA.

IFI SE RÉSERVE LE DROIT DE MODIFIER LES PRODUITS DE CE CATALOGUE À N'IMPORTE QUEL MOMENT SANS OBLIGATION DE PRÉAVIS. LES FINITIONS MONTRÉES DANS CE CATALOGUE SONT INDICATIVES À CAUSE DES DIFFÉRENCES EN COULEUR INÉVITABLES DUES À LA REPRODUCTION TYPOGRAPHIQUE.

IFI HÄLT SICH DAS RECHT VOR, ZU JEDER ZEIT, DIE PRODUKTE OHNE VORANKÜNDIGUNG ABZUÄNDERN. WEGEN DER UNVERMEIDLICHEN FARBENVERSCHIEDENHEITEN, DIE VON DER TYPOGRAPHISCHEN REPRODUKTION GESCHAFFEN WERDEN, SIND DIE FEINBEARBEITUNGEN IN DIESEM KATALOG ANNÄHERND.

IFI SE RESERVA EL DERECHO DE MODIFICAR LOS PRODUCTOS EN CUALQUIER MOMENTO SIN PREVIO AVISO. LOS ACABADOS REPRODUCIDOS EN ESTE CATALOGONO SON EXACTOS DEBIDO A LAS NORMALES VARIACIONES TIPOGRÁFICAS.

THE CATALOGUE HAS BEEN PRODUCED THROUGH THE COLLABORATION OF:
Il catalogo è stato realizzato con la collaborazione di:

- Art Direction
studiopieri web & graphic agency
IFI Marketing Department

© COPYRIGHT IFI S.p.A., TAVULLIA (PU) ITALIA,
2010, 2011, 2013, 2014, 2015, 2016, 2017, 2018

- **TUTTI I DIRITTI RISERVATI**
- All rights reserved

03/2018

PRODUCTS MAY BE PROTECTED BY PATENT AND/OR DESIGN
I prodotti possono essere tutelati da brevetto e/o da design
Les produits peuvent être protégés par brevet et/ou sur leur design
Die Produkte können vom Patent und/oder Design geschützt sein
Los productos pueden ser protegidos por patente y por diseño

ifi.it

#ifi1962



ADIMEMBER



Main Partner



OFFICIAL TECHNICAL SPONSOR



IFI S.p.A.
Strada Selva Grossa 28/30
61010 TAVULLIA (Pesaro) - Italy
Tel. +39 0721 20021
Fax +39 0721 201773
ifi.it - info@ifi.it - export@ifi.it

INDUSTRIEIFI®